

## SIPMOS<sup>®</sup> Small-Signal Transistor

- N channel
- Enhancement mode
- Avalanche rated
- $V_{GS(th)} = 2.1 \dots 4.0 \text{ V}$

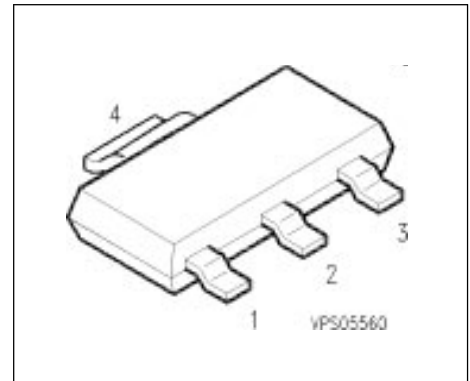

Pin 1	Pin 2	Pin 3	Pin 4
G	D	S	D

Type	$V_{DS}$	$I_D$	$R_{DS(on)}$	Package	Marking
BSP 298	400 V	0.5 A	3 $\Omega$	SOT-223	BSP 298

Type	Ordering Code	Tape and Reel Information
BSP 298	Q67000-S200	E6327

### Maximum Ratings

Parameter	Symbol	Values	Unit
Continuous drain current $T_A = 26 \text{ }^\circ\text{C}$	$I_D$	0.5	A
DC drain current, pulsed $T_A = 25 \text{ }^\circ\text{C}$	$I_{Dpuls}$	2	A
Avalanche energy, single pulse $I_D = 1.35 \text{ A}$ , $V_{DD} = 50 \text{ V}$ , $R_{GS} = 25 \text{ } \Omega$ $L = 125 \text{ mH}$ , $T_j = 25 \text{ }^\circ\text{C}$	$E_{AS}$	130	mJ
Gate source voltage	$V_{GS}$	$\pm 20$	V
Power dissipation $T_A = 25 \text{ }^\circ\text{C}$	$P_{tot}$	1.8	W

## Maximum Ratings

Parameter	Symbol	Values	Unit
Chip or operating temperature	$T_j$	-55 ... + 150	°C
Storage temperature	$T_{stg}$	-55 ... + 150	
Thermal resistance, chip to ambient air	$R_{thJA}$	≤ 70	K/W
Thermal resistance, junction-soldering point <sup>1)</sup>	$R_{thJS}$	≤ 10	
DIN humidity category, DIN 40 040		E	
IEC climatic category, DIN IEC 68-1		55 / 150 / 56	

1) Transistor on epoxy pcb 40 mm x 40 mm x 1,5 mm with 6 cm<sup>2</sup> copper area for drain connection

## Electrical Characteristics, at $T_j = 25^\circ\text{C}$ , unless otherwise specified

Parameter	Symbol	Values			Unit
		min.	typ.	max.	

### Static Characteristics

Drain- source breakdown voltage $V_{GS} = 0 \text{ V}, I_D = 0.25 \text{ mA}, T_j = 0^\circ\text{C}$	$V_{(BR)DSS}$	400	-	-	V
Gate threshold voltage $V_{GS} = V_{DS}, I_D = 1 \text{ mA}$	$V_{GS(th)}$	2.1	3	4	
Zero gate voltage drain current $V_{DS} = 400 \text{ V}, V_{GS} = 0 \text{ V}, T_j = 25^\circ\text{C}$ $V_{DS} = 400 \text{ V}, V_{GS} = 0 \text{ V}, T_j = 125^\circ\text{C}$	$I_{DSS}$	-	0.1 10	1 100	μA
Gate-source leakage current $V_{GS} = 20 \text{ V}, V_{DS} = 0 \text{ V}$	$I_{GSS}$	-	10	100	
Drain-Source on-state resistance $V_{GS} = 10 \text{ V}, I_D = 0.5 \text{ A}$	$R_{DS(on)}$	-	2.2	3	Ω

**Electrical Characteristics, at  $T_j = 25^\circ\text{C}$ , unless otherwise specified**

Parameter	Symbol	Values			Unit
		min.	typ.	max.	

**Dynamic Characteristics**

Transconductance $V_{DS} \geq 2 * I_D * R_{DS(on)max}, I_D = 0.5 \text{ A}$	$g_{fs}$	0.5	1.2	-	S
Input capacitance $V_{GS} = 0 \text{ V}, V_{DS} = 25 \text{ V}, f = 1 \text{ MHz}$	$C_{iss}$	-	300	400	pF
Output capacitance $V_{GS} = 0 \text{ V}, V_{DS} = 25 \text{ V}, f = 1 \text{ MHz}$	$C_{oss}$	-	50	75	
Reverse transfer capacitance $V_{GS} = 0 \text{ V}, V_{DS} = 25 \text{ V}, f = 1 \text{ MHz}$	$C_{rss}$	-	20	30	
Turn-on delay time $V_{DD} = 30 \text{ V}, V_{GS} = 10 \text{ V}, I_D = 0.3 \text{ A}$ $R_{GS} = 50 \Omega$	$t_{d(on)}$	-	10	15	ns
Rise time $V_{DD} = 30 \text{ V}, V_{GS} = 10 \text{ V}, I_D = 0.3 \text{ A}$ $R_{GS} = 50 \Omega$	$t_r$	-	25	40	
Turn-off delay time $V_{DD} = 30 \text{ V}, V_{GS} = 10 \text{ V}, I_D = 0.3 \text{ A}$ $R_{GS} = 50 \Omega$	$t_{d(off)}$	-	30	40	
Fall time $V_{DD} = 30 \text{ V}, V_{GS} = 10 \text{ V}, I_D = 0.3 \text{ A}$ $R_{GS} = 50 \Omega$	$t_f$	-	20	30	

**Electrical Characteristics, at  $T_j = 25^\circ\text{C}$ , unless otherwise specified**

Parameter	Symbol	Values			Unit
		min.	typ.	max.	
<b>Reverse Diode</b>					
Inverse diode continuous forward current $T_A = 25^\circ\text{C}$	$I_S$	-	-	0.5	A
Inverse diode direct current, pulsed $T_A = 25^\circ\text{C}$	$I_{SM}$	-	-	2	
Inverse diode forward voltage $V_{GS} = 0\text{ V}, I_F = 1\text{ A}, T_j = 25^\circ\text{C}$	$V_{SD}$	-	0.95	1.2	V
Reverse recovery time $V_R = 100\text{ V}, I_F = I_S, di_F/dt = 100\text{ A}/\mu\text{s}$	$t_{rr}$	-	300	-	ns
Reverse recovery charge $V_R = 100\text{ V}, I_F = I_S, di_F/dt = 100\text{ A}/\mu\text{s}$	$Q_{rr}$	-	2.5	-	$\mu\text{C}$

### Power dissipation

$$P_{\text{tot}} = f(T_A)$$

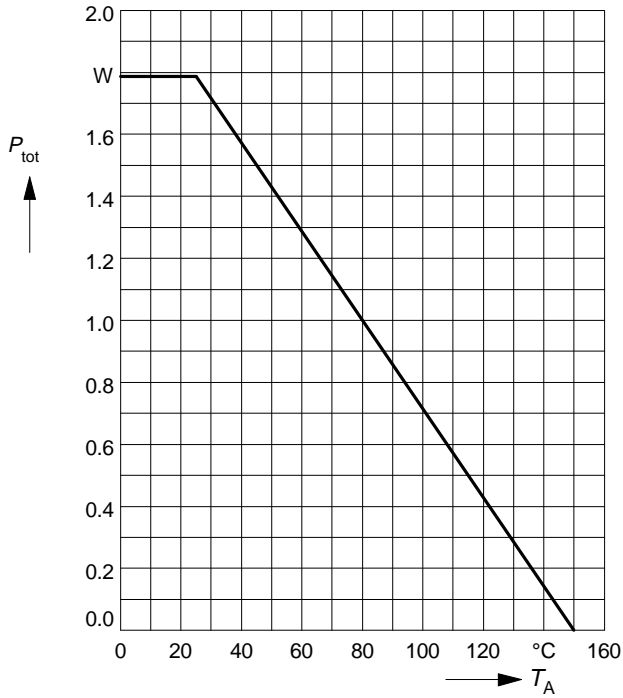

### Drain current

$$I_D = f(T_A)$$

parameter:  $V_{GS} \geq 10 \text{ V}$

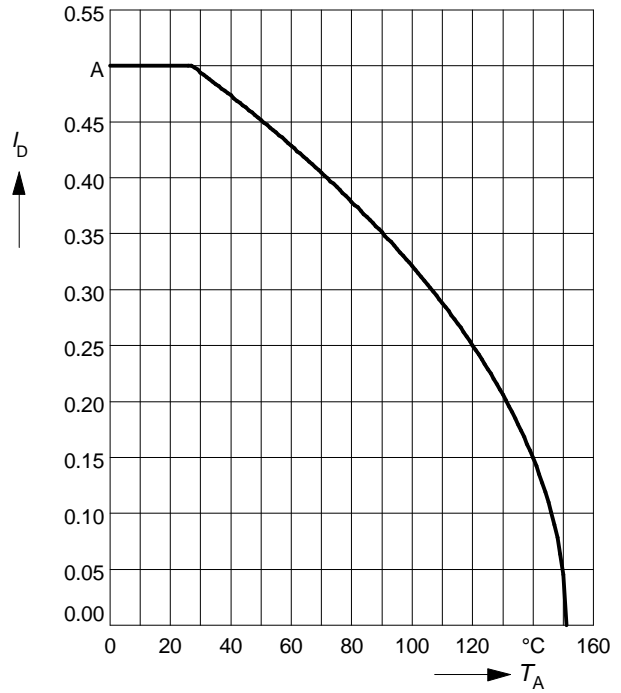

### Safe operating area $I_D = f(V_{DS})$

parameter:  $D = 0, T_C = 25^\circ\text{C}$

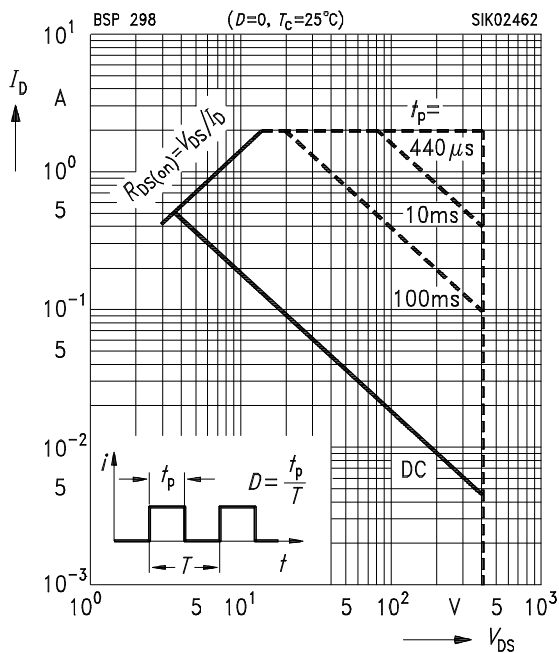

### Transient thermal impedance

$$Z_{\text{thJA}} = f(t_p)$$

parameter:  $D = t_p / T$

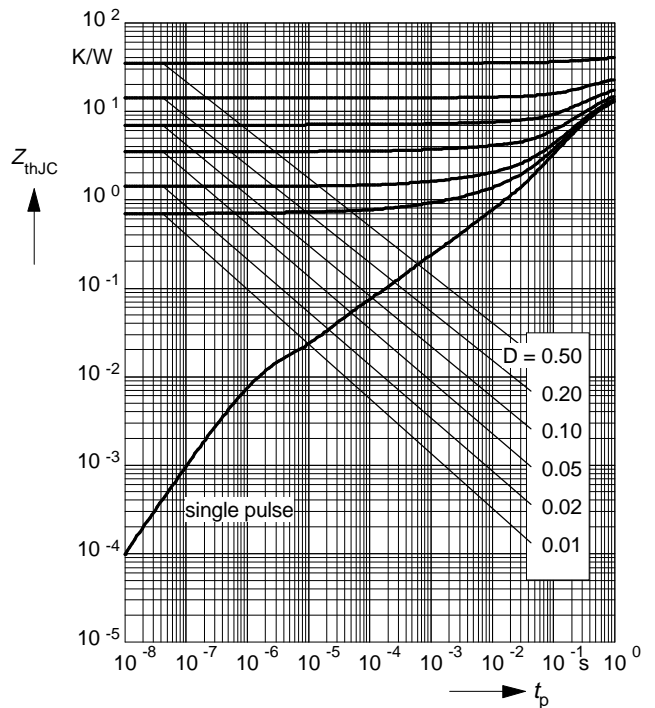

### Typ. output characteristics

$$I_D = f(V_{DS})$$

parameter:  $t_p = 80 \mu s$ ,  $T_j = 25^\circ C$

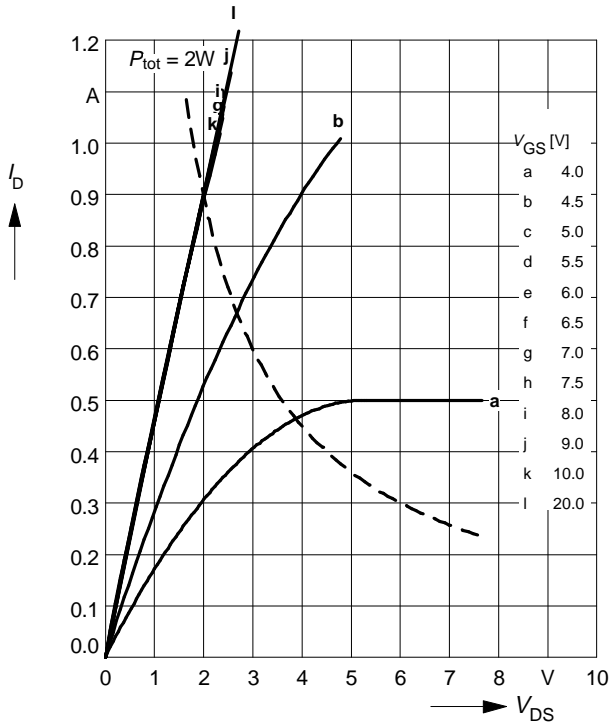

### Typ. drain-source on-resistance

$$R_{DS(on)} = f(I_D)$$

parameter:  $t_p = 80 \mu s$ ,  $T_j = 25^\circ C$

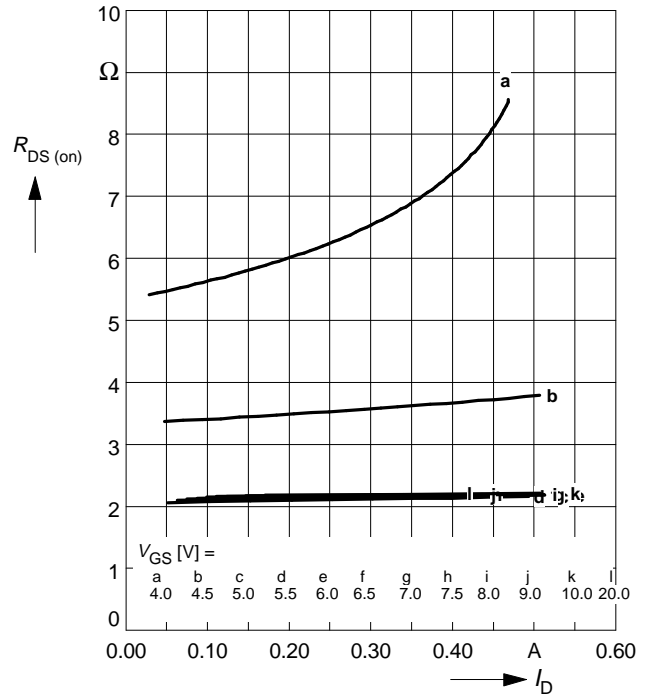

### Typ. transfer characteristics $I_D = f(V_{GS})$

parameter:  $t_p = 80 \mu s$

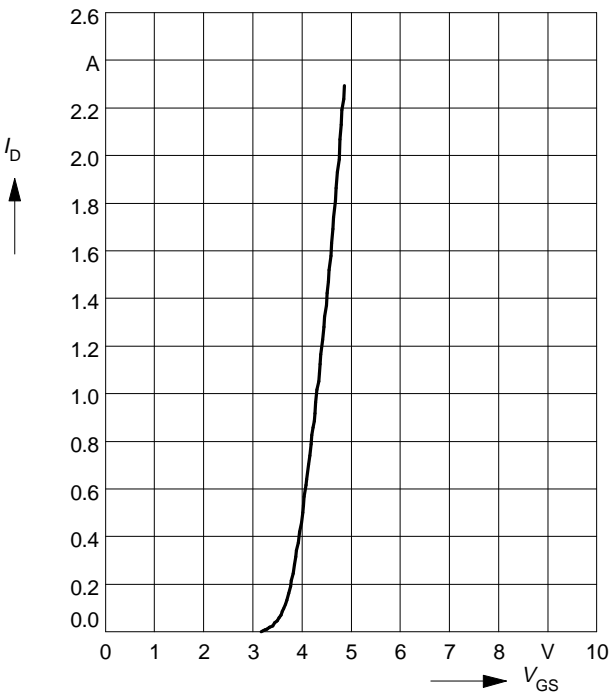

### Typ. forward transconductance $g_{fs} = f(I_D)$

parameter:  $t_p = 80 \mu s$

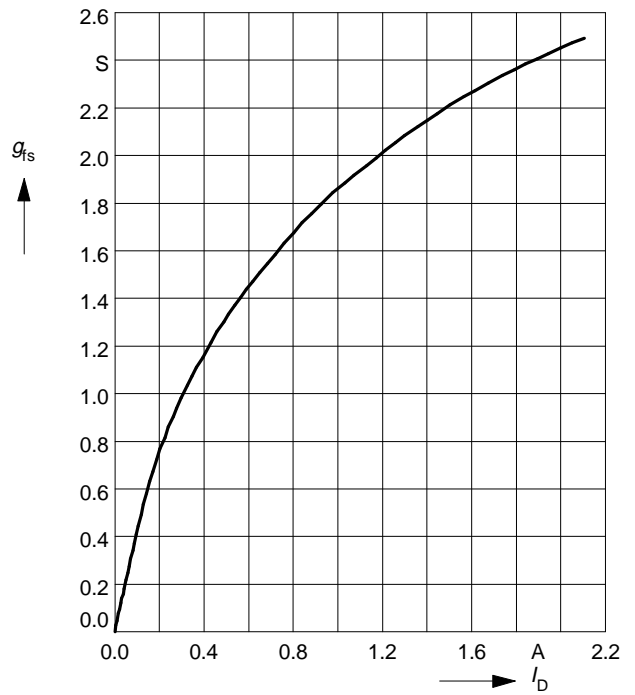

### Drain-source on-resistance

$$R_{DS(on)} = f(T_j)$$

parameter:  $I_D = 0.5 \text{ A}$ ,  $V_{GS} = 10 \text{ V}$

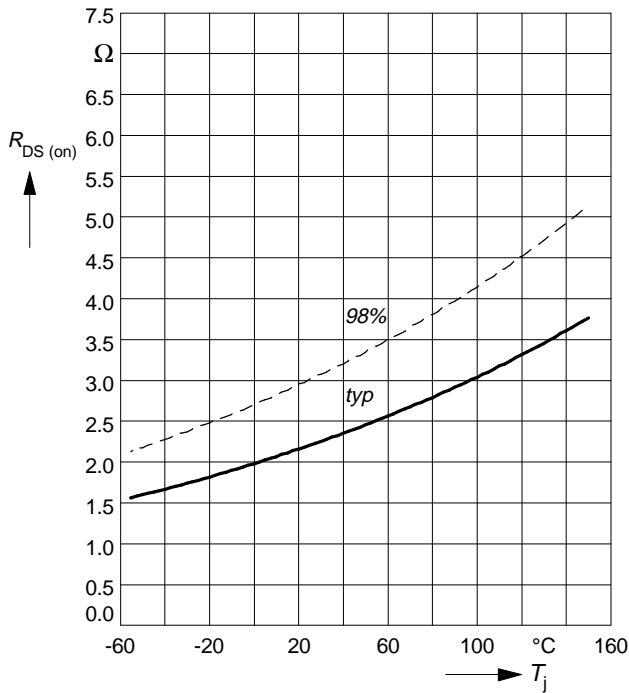

### Gate threshold voltage

$$V_{GS(th)} = f(T_j)$$

parameter:  $V_{GS} = V_{DS}$ ,  $I_D = 1 \text{ mA}$

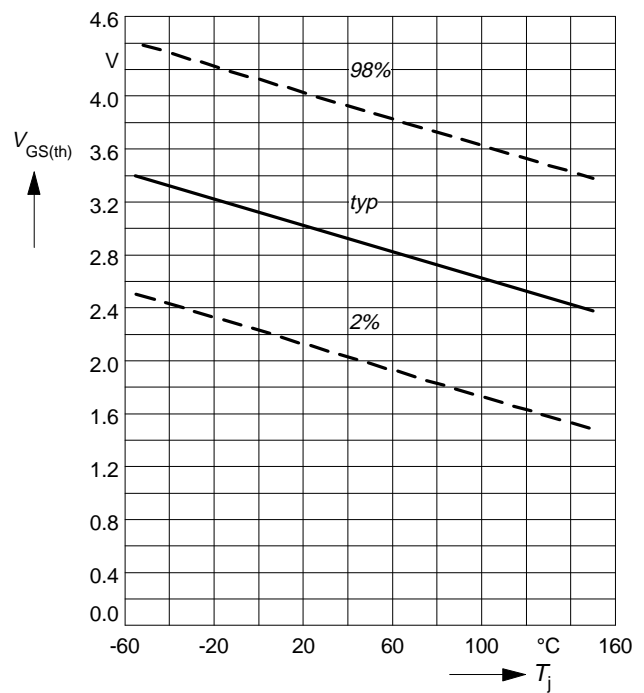

### Typ. capacitances

$$C = f(V_{DS})$$

parameter:  $V_{GS}=0\text{V}$ ,  $f = 1 \text{ MHz}$

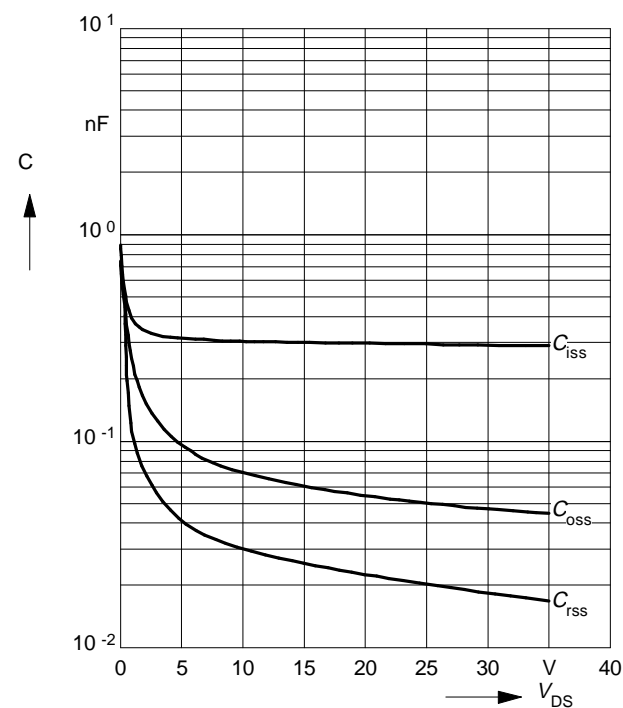

### Forward characteristics of reverse diode

$$I_F = f(V_{SD})$$

parameter:  $T_j$ ,  $t_p = 80 \mu\text{s}$

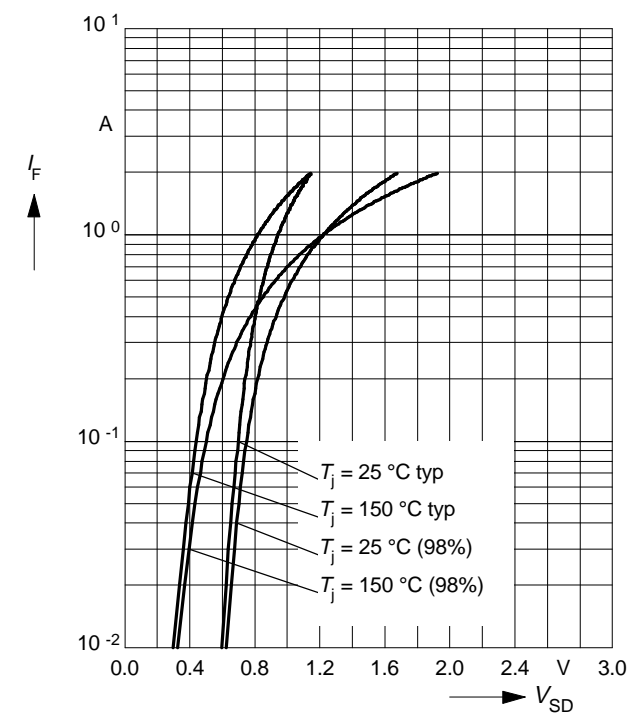

### Avalanche energy $E_{AS} = f(T_j)$

parameter:  $I_D = 1.35 \text{ A}$ ,  $V_{DD} = 50 \text{ V}$   
 $R_{GS} = 25 \Omega$ ,  $L = 125 \text{ mH}$

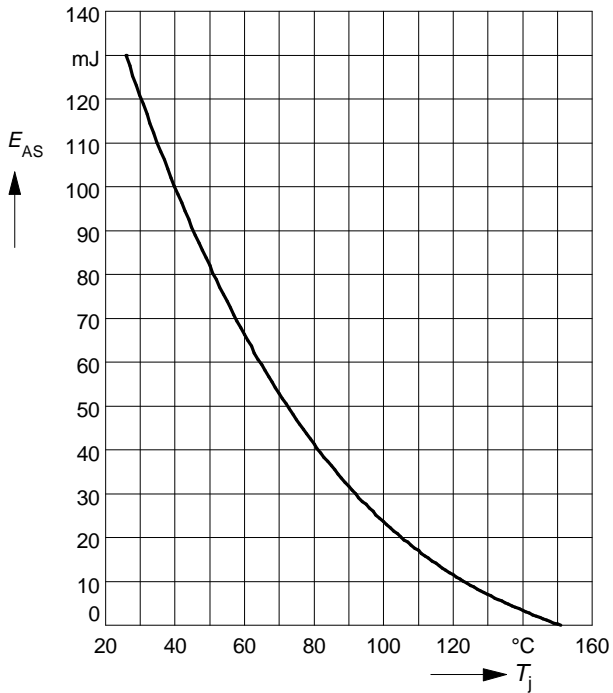

### Drain-source breakdown voltage $V_{(BR)DSS} = f(T_j)$

$V_{(BR)DSS} = f(T_j)$

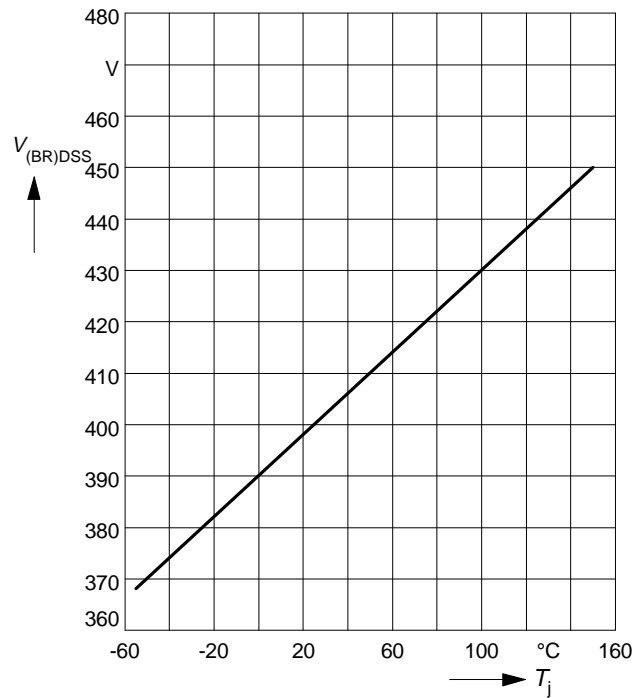

### Safe operating area $I_D = f(V_{DS})$

parameter:  $D = 0.01$ ,  $T_C = 25^\circ\text{C}$

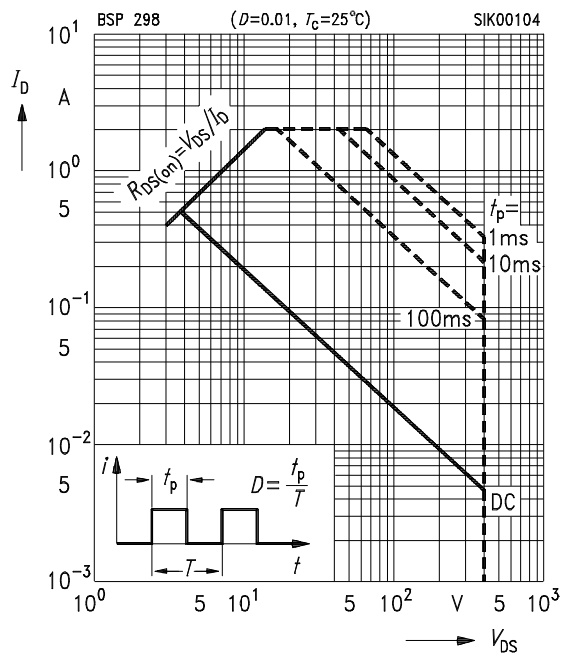



### Package outlines

SOT-223

Dimensions in mm

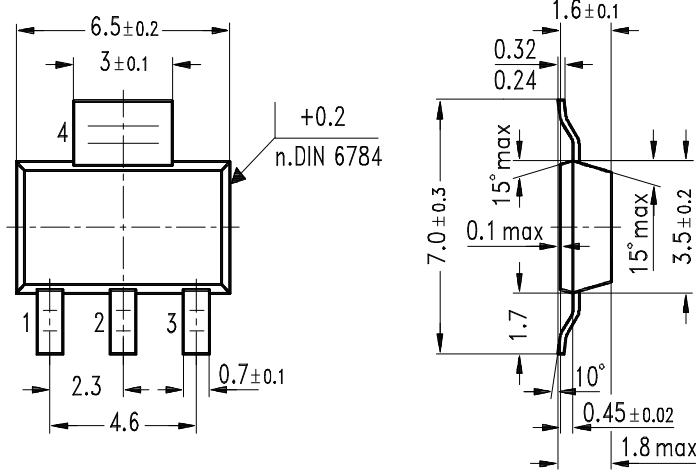

GPS05560