

Savant DigiFlow 6710M-66, Digital Flow Totalizer and Flow Rate Meter

SAVANT ELECTRONICS INC.

1670-3, Sec.1, Huanzhong road, Taichung 40761, Taiwan

Tel : 886 4 2425 5578 Fax : 886 4 2425 0396

Email : savantco@ms65.hinet.net

Website : www.homewaterfilter.com.tw

Features :

- Flow totalizing up to 99999 liters
- Flow rate display from 2.4 – 60.0 liter/min.
- Battery operated, 2 AA batteries
- Low battery power alert
- Automatic data memorized when battery power is off

Application :

- ✓ Water cooler
- ✓ Water dispenser
- ✓ Cooling system for machinery

1.0 Electrical :

Operating Voltage : 3 DC Volts

Operating Current : 1.0 mA (work), 0.015 mA (sleep)

2.0 Mechanic :

Electrical Control Box

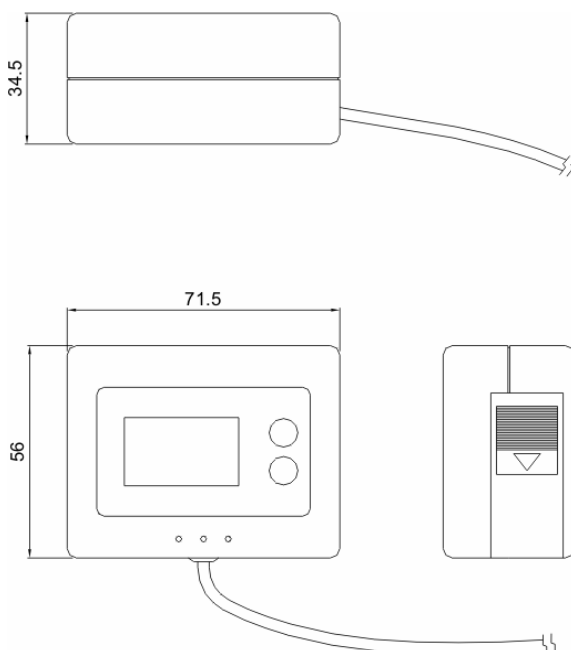

Flow Sensor :

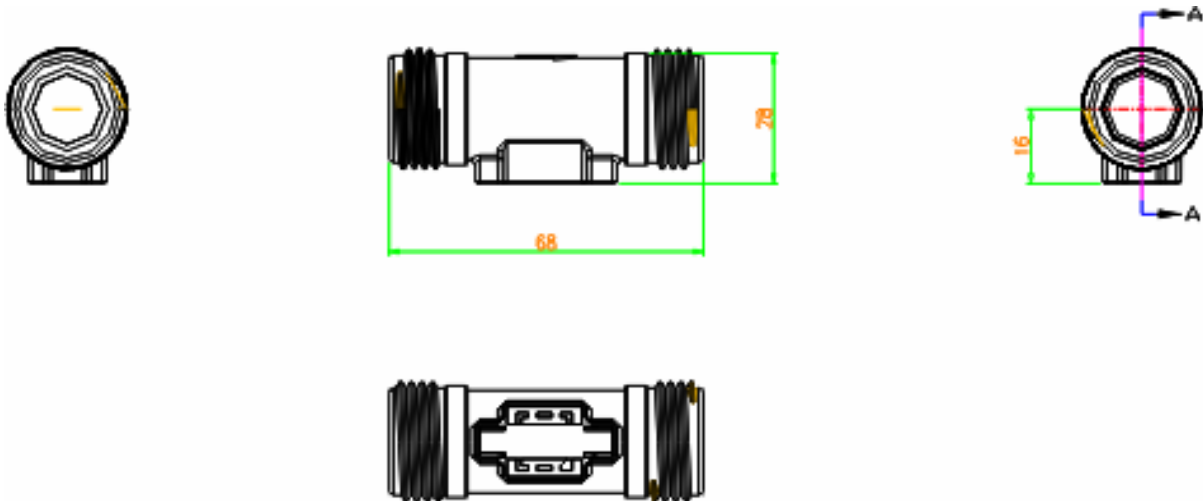

3.0 Application :

Installation Method : Vertical, Horizontal Any angles

Flow Direction : One way

Flow Rate : 2.4 – 60 liter/min

4.0 General :

Temperature : 0 to 80°C

Pressure : Max. 6.0 bar (85 psi)

Weight : 140 g (5.38 oz)

Accuracy : +/- 5%

Connection : 3/4" BSP male

Materials : Sensor Body : PA6, Nylon

Turbine : Plastic Magnet

Shaft of Turbine : 304 stainless steel or ceramic (option)

Control Box Housing : ABS resin

5.0 Operation Guide

5.1 Install Batteries

Slide off the cover case of the battery room, and put into 2 AA batteries. Then slide the cover case back.

5.2 Connecting Fitting

The specification of the DigiFlow 6710M-66 connectors is 3/4" BSP male.

5.3 Operating

The DigiFlow 6710M-66 will automatically turn on when there is water flowing through the sensor. It will automatically turn off in 10 seconds when there is no water flowing.

5.4 Display and Mode Selection :

Press the “DISPLAY” button will turn on the LCD of the DigiFlow 6710M-66. Pressing the “DISPLAY” button again could choose to display accumulated flowing volume (flow totalization) or real-time flow rate.

5.5 Reset

Use stick to keep pressing the “RESET” button for 4 seconds, the total measuring volume will be reset to be zero.

5.6 Low Battery Power Alert

When the battery power lower than normal working level, the buzzer will beep twice to notice and the battery symbol on the screen will blink to notice user to change the battery. Once the batteries are replaced, the alert will be released. The data will be kept in memory and stored back when user replace the batteries.